



Ventvisor® Deflector

**For proper installation and best possible fit, please read all instructions BEFORE you begin.
For technical assistance or to obtain missing parts, please call Customer Relations at 1-800-241-7219.**

Important Safety Information



- CAUTION - Before driving, ensure that the vent visor is properly secured to vehicle.
- Do not use automatic "brush-style" car washes.
- Do not use cleaning solvents of any kind.
- Periodically check all components for tightness.

Contents - 2 Piece Set **NOTE:** Actual product may vary from illustration.

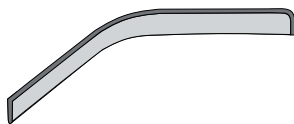

Front Driver Side Visor

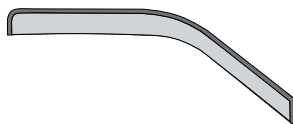

Front Passenger Side Visor



Alcohol Pad x2

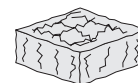

Scotch Brite pad

Contents - 4 Piece Set



Front Driver Side Visor



Front Passenger Side Visor



Alcohol Pad x4



Scotch Brite pad



Rear Driver Side Visor

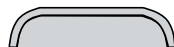

Rear Passenger Side Visor

Tools Required



Car Wash Supplies



Clean Towel

Preparation Before Painting / Installation

- A trial fit is recommended to ensure proper positioning and fit.
- Check fit of parts before painting as we will not accept the return of modified or painted parts.
- Wash and dry your vehicle to remove any debris and/or dirt from the installation area.

Installation Steps

NOTE: Actual application may vary slightly from illustrations.

Lower driver side window.

Buff inside felt surface of window channel with scotch brite pad, and clean with alcohol pad.

Alcohol Pad

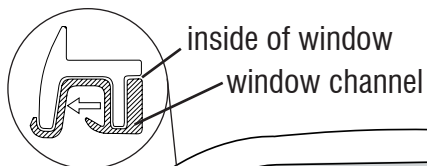
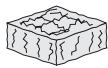

inside of window

window channel

1

2

Remove tape liner from front & rear flanges. Peel back 2" of tape liner from each end of top flange.

Slide the front end flange of the visor inside window channel. Then slide top and rear end flanges into position inside channel.

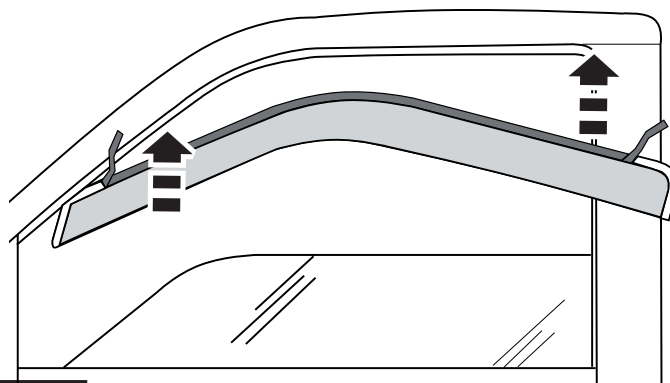
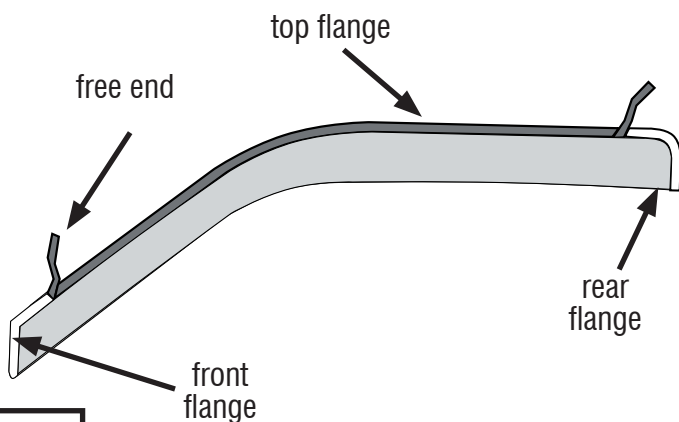

3

4

With visor in final position, remove remaining tape liner by pulling on free ends.

Run your finger along inside of window channel to ensure proper adhesion of taped flange to felt surface. Roll window up, and allow 24 hours for adhesive to cure.

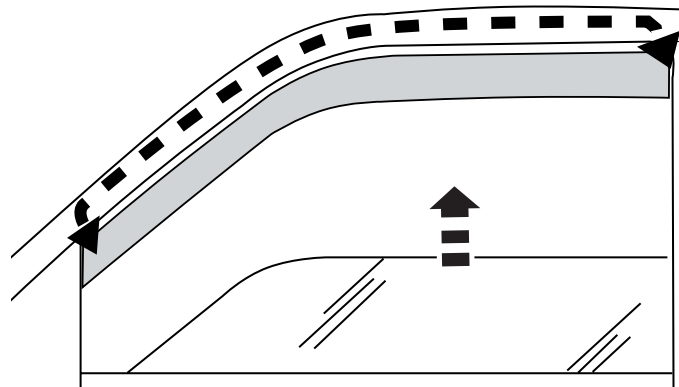
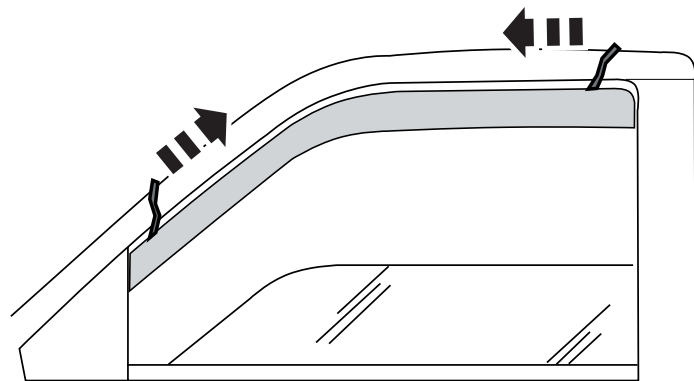

5

6

4 Piece Set

If applicable, rear visor attached directly to painted surface.

Pop out visor installed

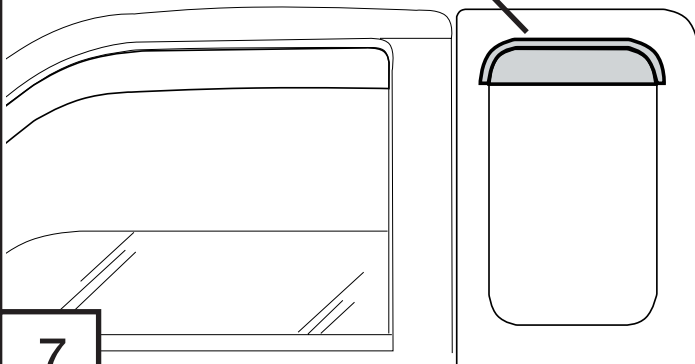

7

Repeat for opposite side.

Care and Cleaning

- Wash only with mild soap & dry with a clean cloth.

Congratulations!

You have purchased one of the many quality Auto Ventshade™ branded products offered by Lund International, Inc. We take the utmost pride in our products and want you to enjoy years of satisfaction from your investment. We have made every effort to ensure that your product is top quality in terms of fit, durability, finish and ease of installation.



AUTO VENTSHADE™

Lund International, Ventshade Accessories Division
655 Raco Drive, Lawrenceville, GA 30045
800-241-7219 • Fax 770-339-5839 • Visit us at lundinternational.com



© 2005 Lund International, Inc. All rights reserved.
Auto Ventshade™, the Auto Ventshade™ logo and the AVS™ logo are trademarks of Lund International, Inc.





Ventvisor® Deflector

Pour obtenir une installation correcte et le meilleur ajustement possible, lire toutes les instructions AVANT de commencer.
Pour toute assistance technique ou obtention de pièces manquantes, appeler le service des relations avec la clientèle au 1-800-241-7219.

Informations importantes concernant la sécurité



- **ATTENTION** – Avant de conduire, s'assurer que la visière est solidement assujettie sur le véhicule.
- Ne pas utiliser les stations de lavage de voitures à brosses.
- Ne pas utiliser de solvants.
- Vérifier régulièrement le serrage des composants.

Contenu - Ensemble 2 pièces

NOTE: Le produit réel peut changer de l'illustration.

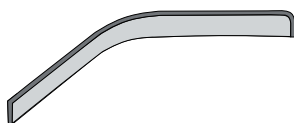

Visière avant
côté conducteur

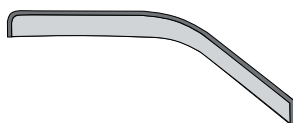

Visière avant
côté passager



Tampons à l'alcool (2)

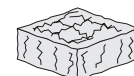

tampon à récurer
Scotch Briter

Contenu - Ensemble 4 pièces



Visière avant
côté conducteur



Visière avant
côté passager



Tampons à l'alcool (4)

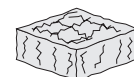

tampon à récurer
Scotch Briter



Visière arrière
côté conducteur



Visière arrière
côté passager

Outils nécessaires



Fournitures pour
lavage de voiture



Serviette propre

Préparation pour la peinture/l'installation

- Il est recommandé de procéder à un essai pour s'assurer que le positionnement et l'ajustement sont corrects.
- Vérifier l'ajustement des pièces avant peinture, car nous n'acceptons pas le retour de pièces modifiées ou peintes.
- Laver les glissières de glaces de la portière du véhicule pour éliminer toute poussière et tous débris.
- Sécher les glissières avec une serviette propre.

Étapes d'installation

REMARQUE : La méthode d'application peut être légèrement différente de celle représentée par les illustrations.

Abaisser la glace côté conducteur.

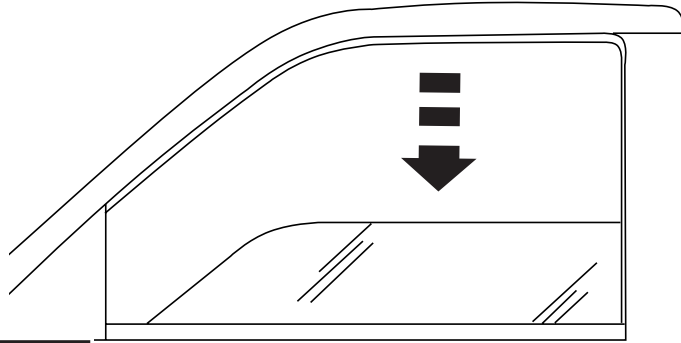

1

Alcohol Pad



Frotter la surface feutrée intérieure de la glissière de la glace avec le tampon Scotch Brite, puis la nettoyer avec un tampon à l'alcool.

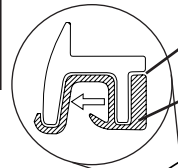

Intérieur de la glace
Glissière de la glace

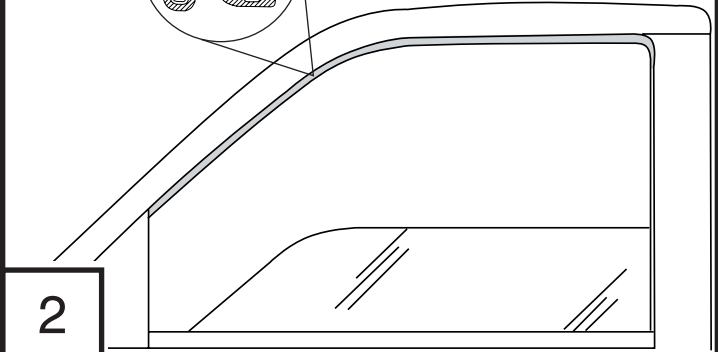

2

Retirer la protection d'adhésif des rebords avant et arrière. Décoller environ 5 cm (2 po) de protection d'adhésif à chaque extrémité du rebord supérieur.

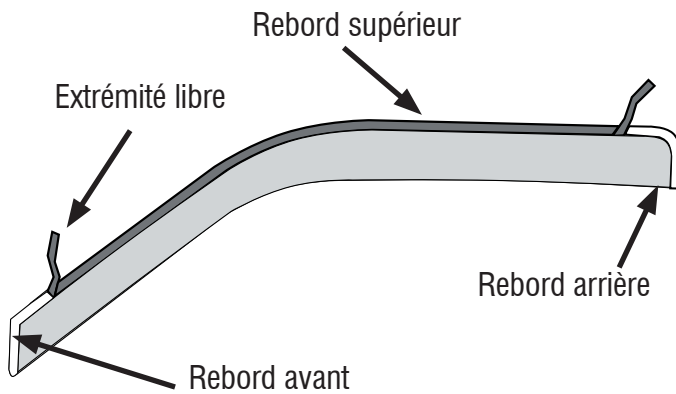

3

Faire glisser le rebord de l'extrémité avant de la visière à l'intérieur de la glissière de la glace. Faire ensuite glisser le rebord supérieur et celui de l'extrémité arrière pour les mettre en place à l'intérieur de la glissière.

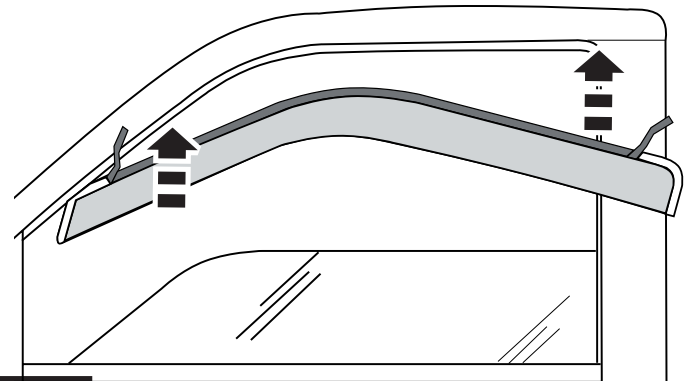

4

Une fois la visière en position finale, retirer le reste de la protection d'adhésif en tirant sur les extrémités libres.

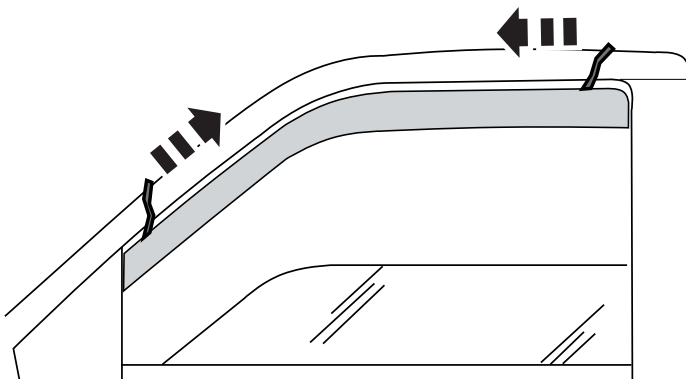

5

Faire glisser le doigt tout le long de l'intérieur de la glissière de la glace, pour assurer la bonne adhésion du rebord collé sur la surface feutrée. Relever la glace et la laisser remontée pendant 24 heures pour permettre à l'adhésif de durcir.

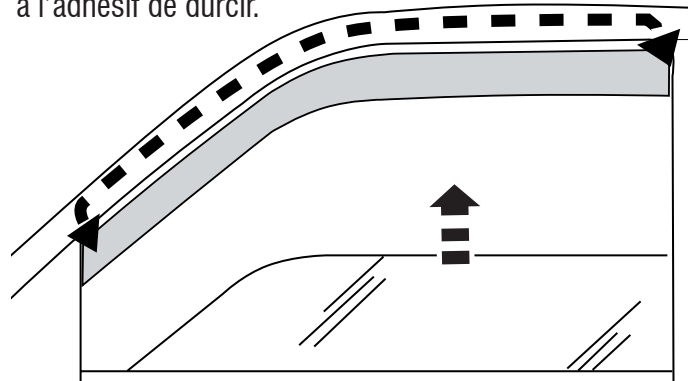

6

Ensemble 4 pièces

Le cas échéant, fixer la visière arrière directement sur la surface peinte.

Visière amovible installée

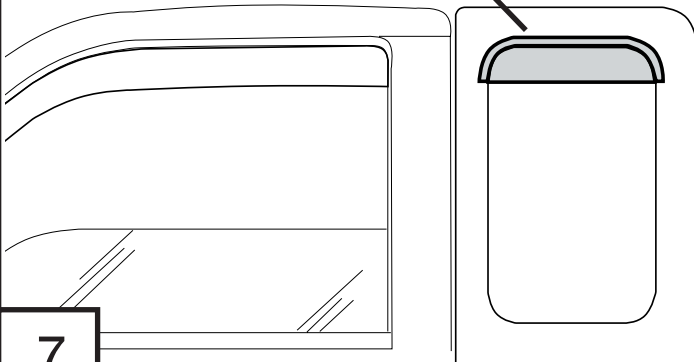

Répéter la procédure du côté opposé.

Entretien et nettoyage

- Laver exclusivement avec de l'eau savonneuse et sécher avec un chiffon propre.

Félicitations !

Vous avez acheté l'un des nombreux produits de qualité Auto Ventshade™ fabriqués par Lund International, Inc. Nous sommes extrêmement fiers de nos produits et souhaitons que vous tiriez des années de satisfaction de votre investissement. Nous avons pris toutes les mesures nécessaires pour assurer que ce produit est d'une qualité supérieure en ce qui concerne l'ajustement, la durabilité, la finition et la facilité d'installation.



AUTO VENTSHADE™

Lund International, Ventshade Accessories Division

655 Raco Drive, Lawrenceville, GA 30045, USA

800-241-7219 • Fax 770-339-5839 • Visitez notre site lundinternational.com



© 2005 Lund International, Inc. Tous droits réservés.

Auto Ventshade™, le logo Auto Ventshade™ et le logo AVS™ sont des marques déposées de Lund International, Inc.





Ventvisor® Deflector

Para una instalación adecuada y el mejor ajuste posible, lea todas las instrucciones ANTES de comenzar. Si desea recibir asistencia técnica u obtener piezas faltantes, llame al Servicio al cliente al 1-800-241-7219.

Información importante de seguridad



- **PRECAUCIÓN** - Antes de conducir, asegúrese de que la visera esté correctamente anclada al vehículo.
- No utilice servicios automáticos de limpieza de vehículos que utilizan cepillos.
- No utilice limpiadores al solvente de ningún tipo.
- Compruebe periódicamente que todos los componentes estén ajustados.

Contenido - Juego de dos piezas

NOTA: El producto real puede variar de la ilustración.

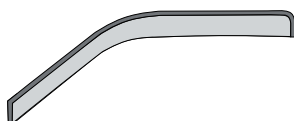

Visera delantera del conductor

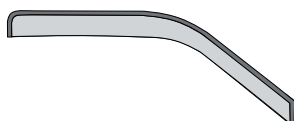

Visera delantera del acompañante



Paños esterilizados x 2



el paño Scotch Brite

Contenido - Juego de cuatro piezas



Visera delantera del conductor



Visera delantera del acompañante



Paños esterilizados x 4

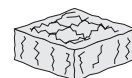

el paño Scotch Brite



Visera trasera del conductor



Visera trasera del acompañante

Herramientas necesarias



Equipo de limpieza de vehículos

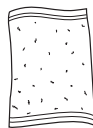

Toalla limpia

Preparación antes de pintar o instalar

- Se recomienda realizar un ajuste de prueba para asegurar el posicionamiento y ajuste correctos.
- Compruebe que las piezas se ajusten correctamente antes de pintarlas, ya que no aceptaremos la devolución de piezas modificadas o pintadas.
- Lave los canales de la ventanilla del vehículo para quitar los desechos y la suciedad.
- Seque los canales de la ventanilla con una toalla limpia.

Pasos de instalación AVISO: La colocación real puede variar con respecto a las ilustraciones.

Baje la ventanilla del conductor.

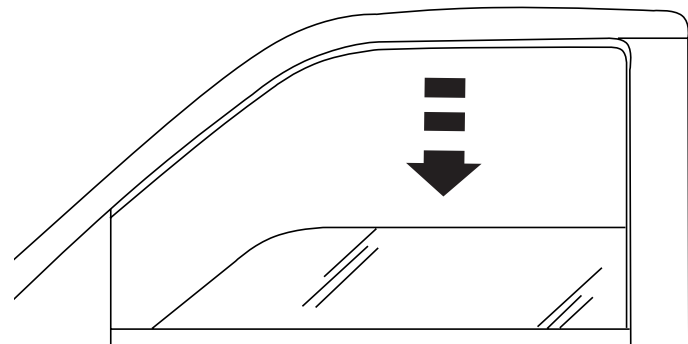

1

Alcohol Pad

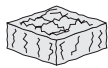

Pula la superficie de fieltro interior del canal de la ventanilla con el paño para restregar Scotch Brite y limpie con un paño esterilizado.

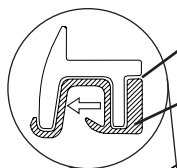

interior de la ventanilla
canal de la ventanilla

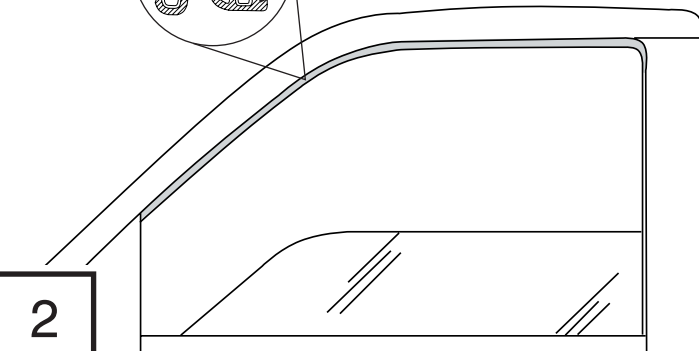

2

Retire la cinta protectora de los rebordes frontales y traseros. Retire 2 pulgs. de cinta protectora de cada uno de los extremos del reborde superior.

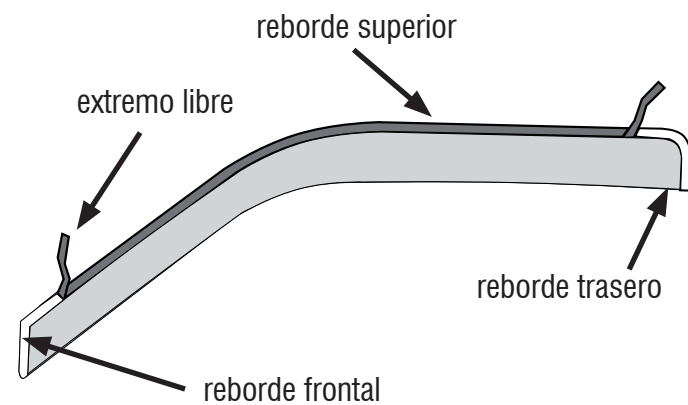

3

Deslice el reborde del extremo delantero de la visera dentro del canal de la ventanilla. Luego deslice los rebordes superior y trasero dentro del canal.

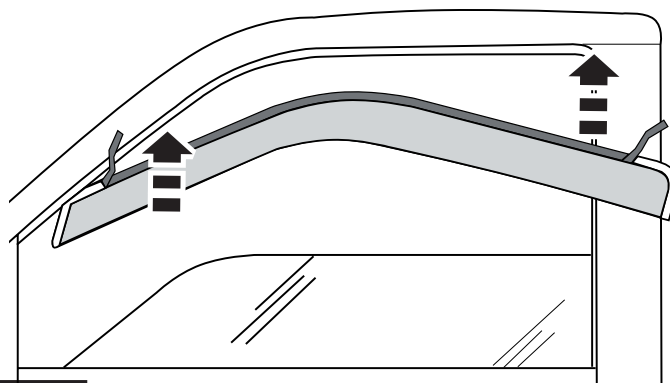

4

Una vez que la visera se encuentra en su posición definitiva, quite la cinta protectora restante tirando de los extremos que quedaron libres.

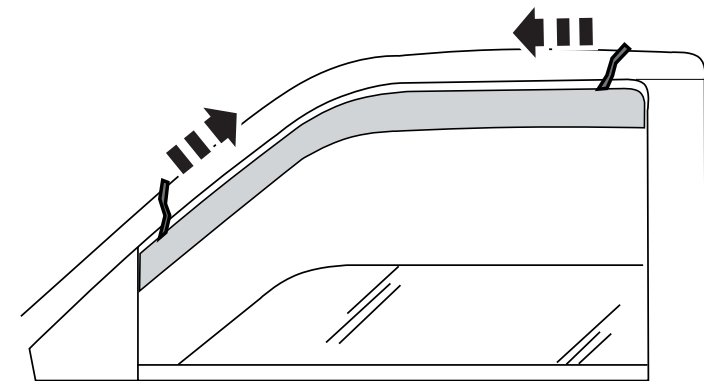

5

Pase el dedo por el interior del canal de la ventanilla para asegurarse de que el reborde encintado se adhiera correctamente a la superficie de fieltro. Cierre la ventanilla y permita que el adhesivo se fije durante 24 horas.

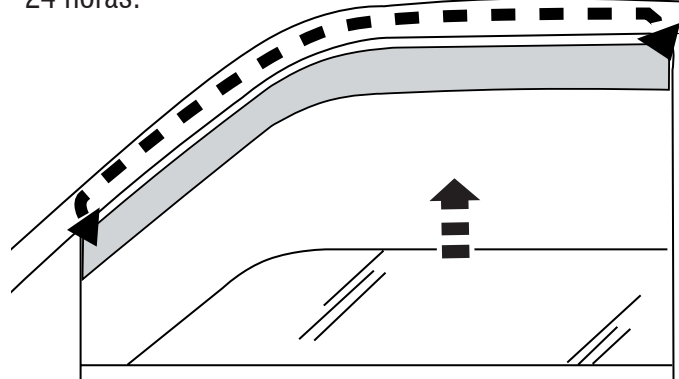

6

Juego de cuatro piezas

Si fuera necesario, coloque la visera trasera directamente sobre la superficie pintada.

Retire la visera colocada

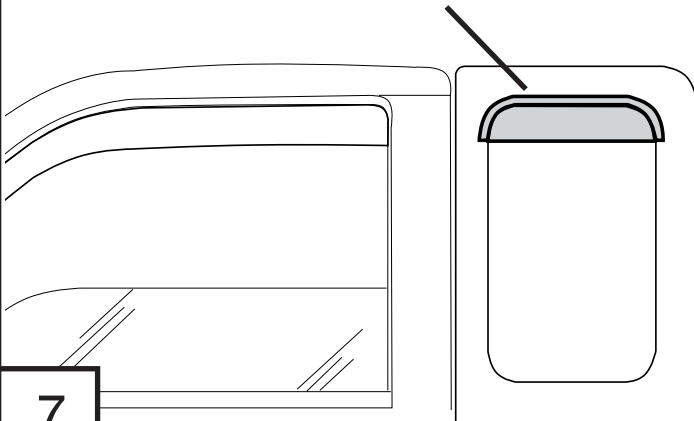

7

Repita el procedimiento para el otro lado del vehículo.

Cuidado y limpieza

- Limpie solamente con agua jabonosa tibia y seque con un paño limpio.

Felicidades

Usted ha comprado uno de los tantos artículos de calidad de Auto Ventshade™ ofrecidos por Lund International, Inc. Nuestros productos son nuestro mayor orgullo. Deseamos que disfrute de años de satisfacción con su inversión. Hemos realizado todos los esfuerzos para asegurarnos de que su producto sea de la mejor calidad en cuanto a ajuste, durabilidad, acabado y facilidad de instalación.



AUTO VENTSHADE™

Lund International, Ventshade Accessories Division

655 Raco Drive, Lawrenceville, GA 30045

800-241-7219 • Fax 770-339-5839 • Visite nuestro sitio Web: lundinternational.com



© 2005 Lund International, Inc. Todos los derechos reservados.
™ Auto Ventshade™, el logo de Auto Ventshade™ y el logo de AVS™ son marcas comerciales de Lund International, Inc.

